

korbo

EDU PASTEL

370 PIECES :: 4+ YEARS OLD

100 ways to spin, learn & play!

A		110x
B		90x
C		50x
D		60x
E		20x
F		20x
G		20x

NEW!

Various Korbo connections

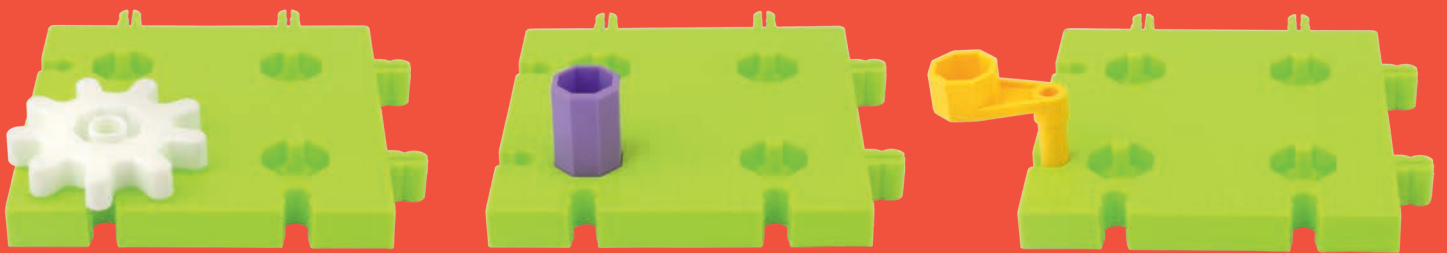
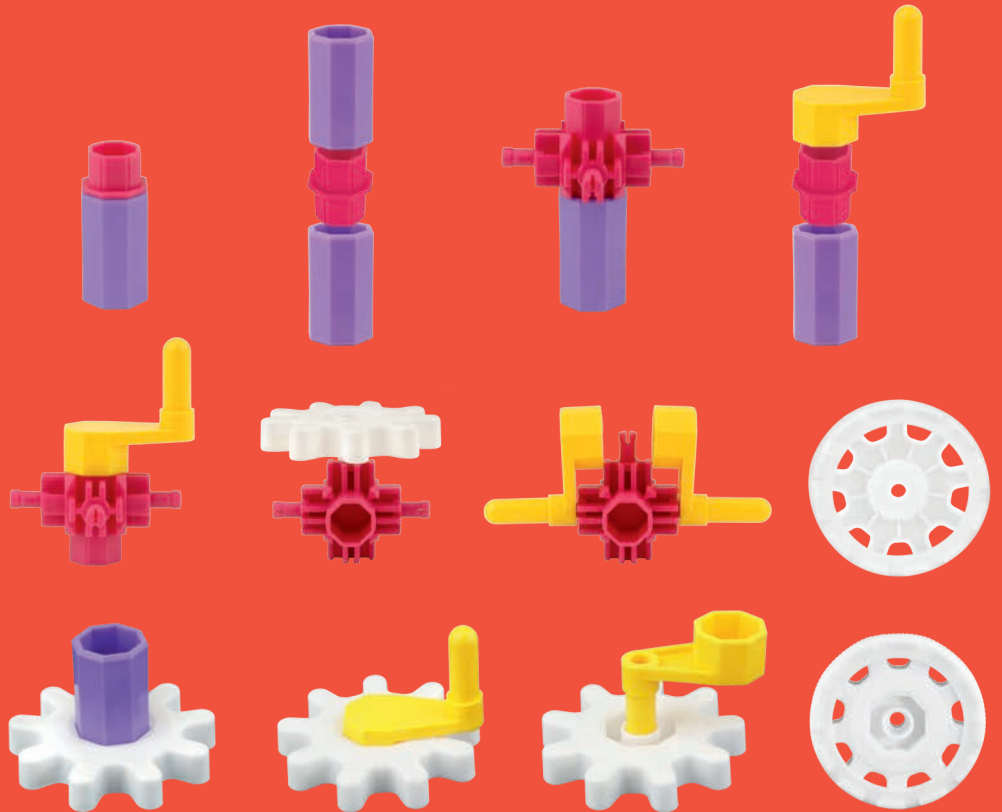

PL Jeżeli element B trudno wchodzi do elementu A lub F włóż go odwrotną stroną.
 GB Once you find it difficult to put the element B into elements A or F please insert it with the reverse side.
 DE Wenn es ist schwer das Element B in die Elemente A oder F zu legen, legen Sie es bitte mit der Rückseite ein.
 RU Если элемент B не входит в элементы A и F попробуйте вставить его обратной стороной.
 ES Si tienes dificultad en entrar el elemento B al elemento A o F, te aconsejamos ponerlo del revés.

3 degrees of difficulty

PL Koło z korbką to koło napędowe. Pamiętaj, lekkość kręcenia konstrukcji zależy, gdzie umiejscowisz korbkę.
 GB The gear with the crank is the driving gear. Remember - spinning effort depends on where you place the crank.
 DE Das Zahnrad mit der Kurbel ist das treibende Zahnrad. Denken Sie daran - die Spinnanstrengung hängt davon ab, wo Sie die Kurbel setzen.
 RU Шестеренка с ручкой является ведущей. Помните – легкость вращения конструкции зависит от того где расположишь ручку.
 ES La rueda con la manivela es la rueda de transmisión. Recuerda, el esfuerzo de giro para mover la construcción dependerá de dónde se coloque la manivela.

PL Każda konstrukcja mechaniczna przy wielokrotnych obrotach luzuje się. Podczas zabawy „serwisuj” swoje konstrukcje dociskając wszystkie elementy, aby poruszały się sprawnie.
 GB Every mechanical construction gets loose after multiple spins. While playing "service" your constructions by tightening all elements together to make the move efficiently.
 DE Jede mechanische Konstruktion löst sich nach mehreren Drehungen. Während des Spiels "Service" Ihre Konstruktionen durch Anziehen aller Elemente zusammen, um den Umzug effizient zu machen.
 RU Каждая механическая конструкция при долгом вращении начинает терять свою прочность. Играя, «проводит техобслуживание» своего механизма. Периодически дожимайте элементы так чтобы конструкции правильно функционировали.
 ES Cada construcción mecánica se suelta tras hacer múltiples giros. Mientras juegas con tu construcción mantén los elementos bien apretados para que se mueva de manera eficiente.



REMI
 04-445 Warszawa, Poland
 ul. Szafarzy 71
 tel. +48 22 858 16 55
 www.korbo.eu

PL Kolorystyka wszystkich konstrukcji jest przykładowa.
 GB Colour combinations of all constructions is only an example.
 DE Die abgebildeten Farbkombinationen der Figuren sind nur Beispiele.
 RU Расцветка всех конструкций случайная.
 NL De kleurencombinaties van alle constructies zijn bij wijze van voorbeeld.
 ES Los colores de todas las construcciones sirven de ejemplo.
 FR Les couleurs de toutes les constructions ce n'est qu'un exemple.

CRADLE



- 6x (Red gear)
- 6x (Green gear)
- 1x (White gear)
- 8x (Red pin)
- 7x (Purple pin)
- 7x (White pin)
- 9x (Red gear)
- 7x (Red gear)
- 4x (Yellow plate)
- 2x (Green plate)

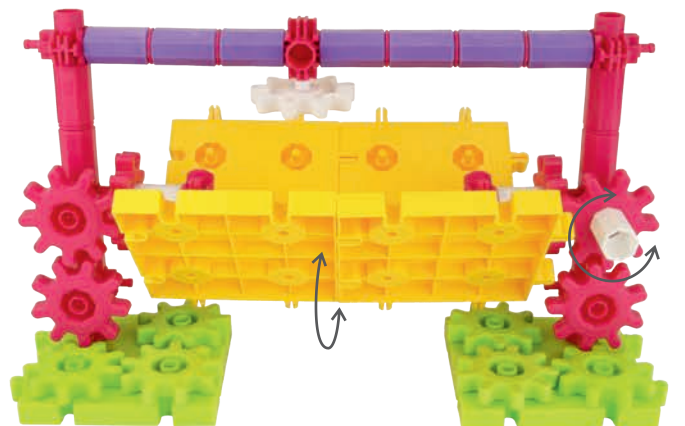
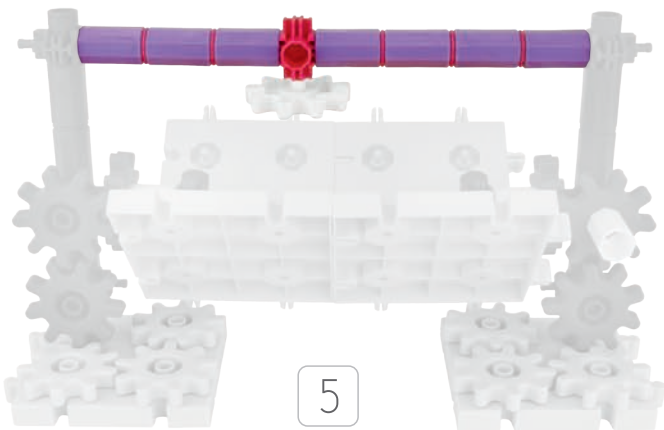
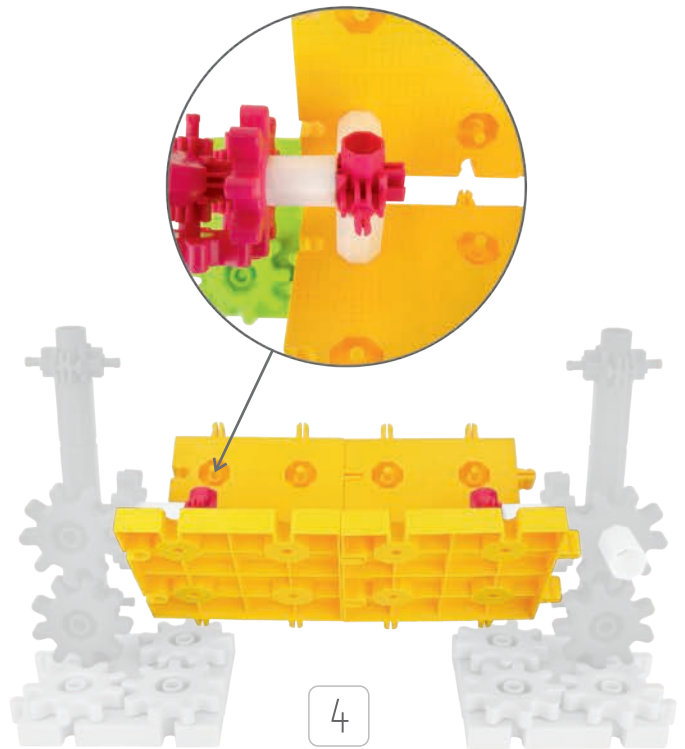
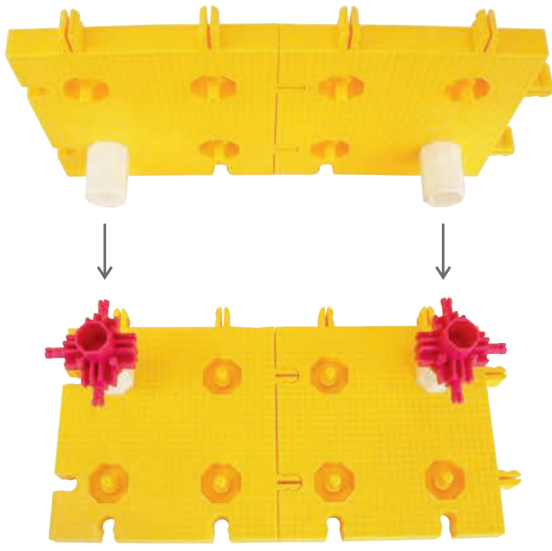
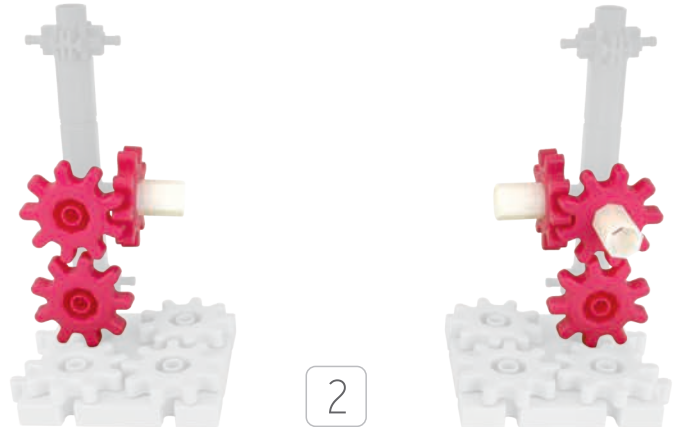
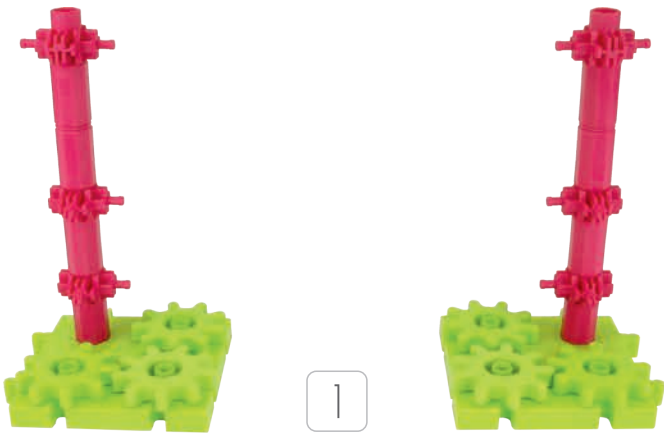

PRAM 1



4 x



12 x



2 x



11 x



12 x



4 x



2 x



4 x

1

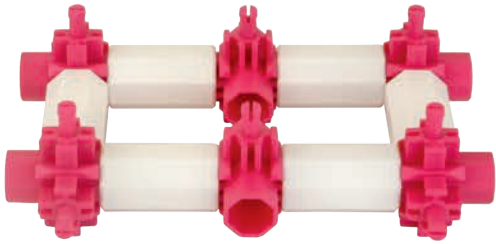

2

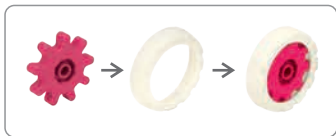
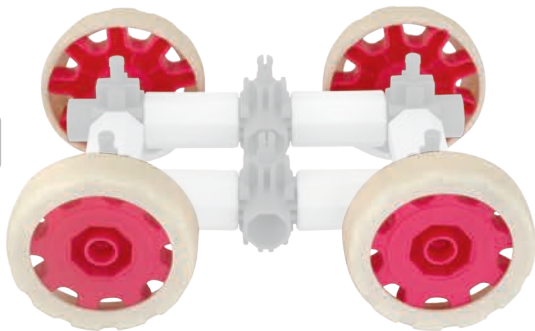

3

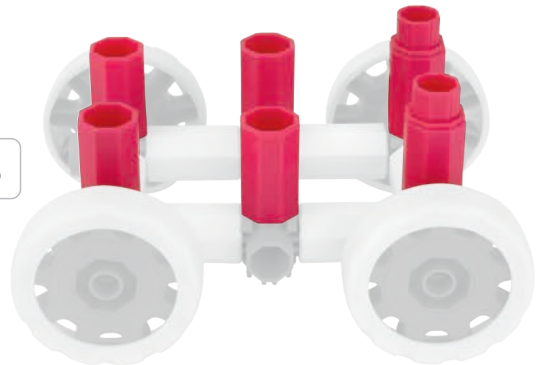

4

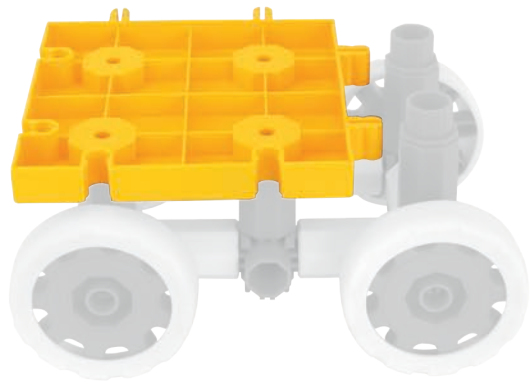

A



B

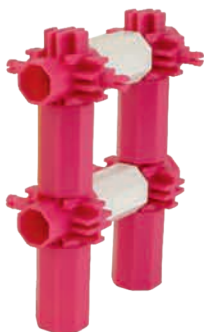

C



5

A

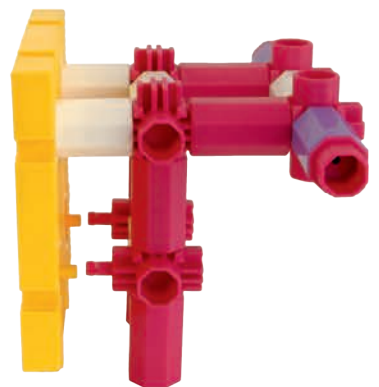

B

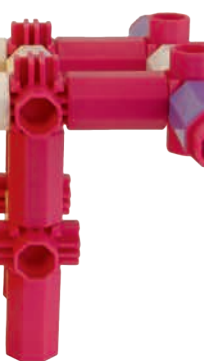

C



6

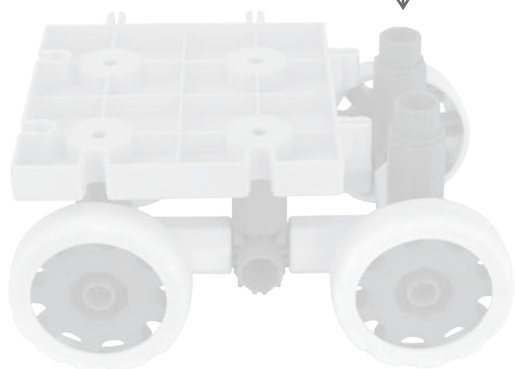

PRAM 2 / PRAM 3



PRAM 1

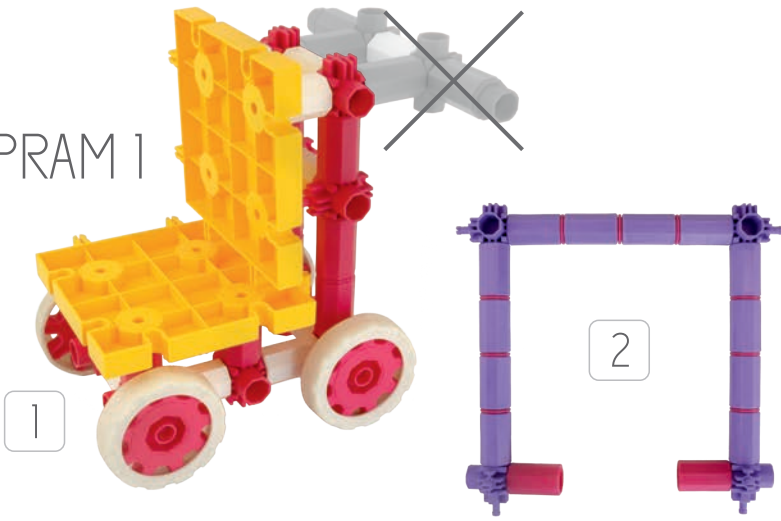

PRAM 2

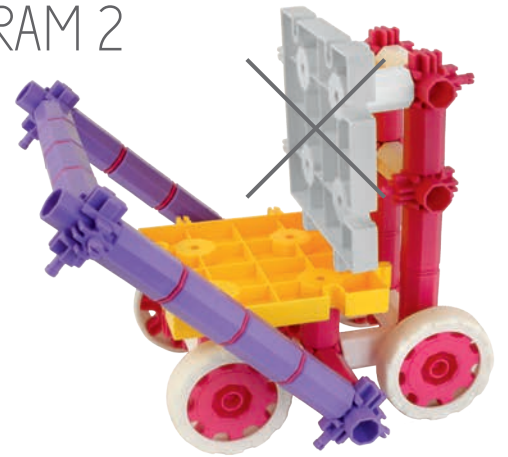

PRAM 2

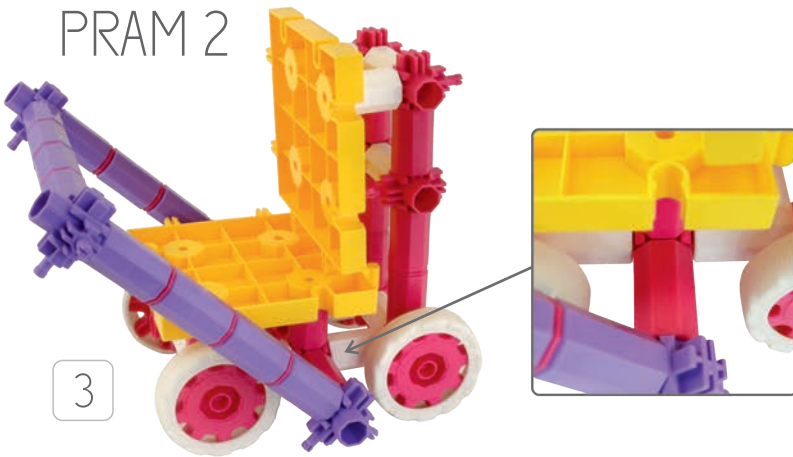

PRAM 3

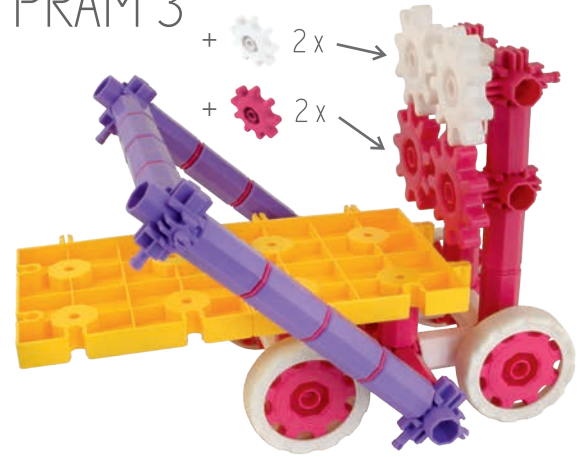

BIKE

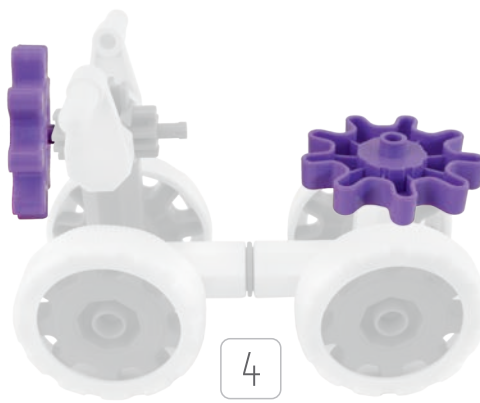
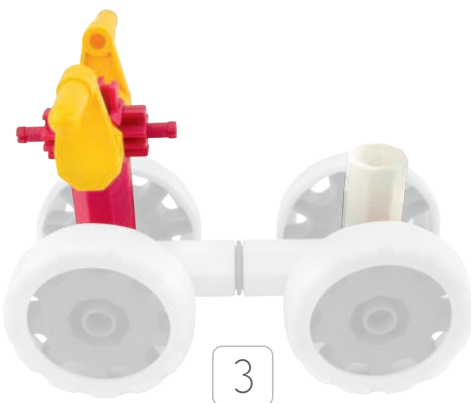
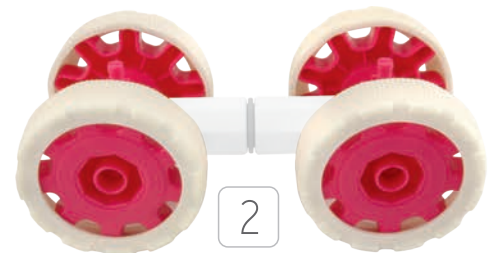
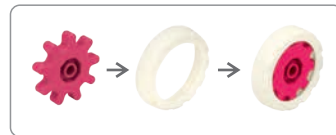
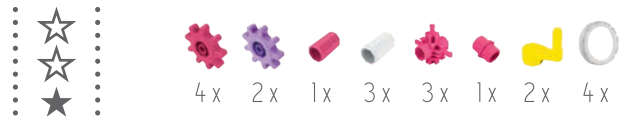

CAR

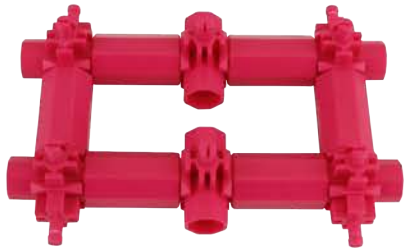

1



2

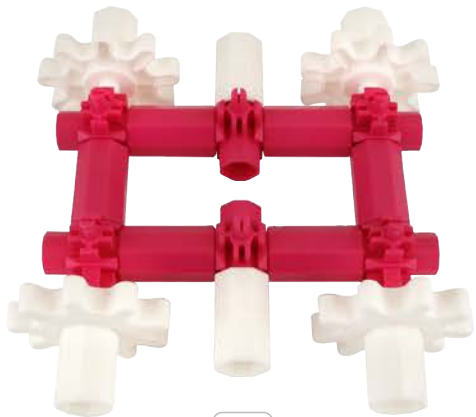

3

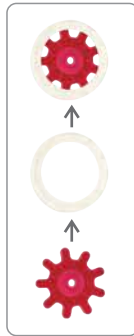

4



5



6

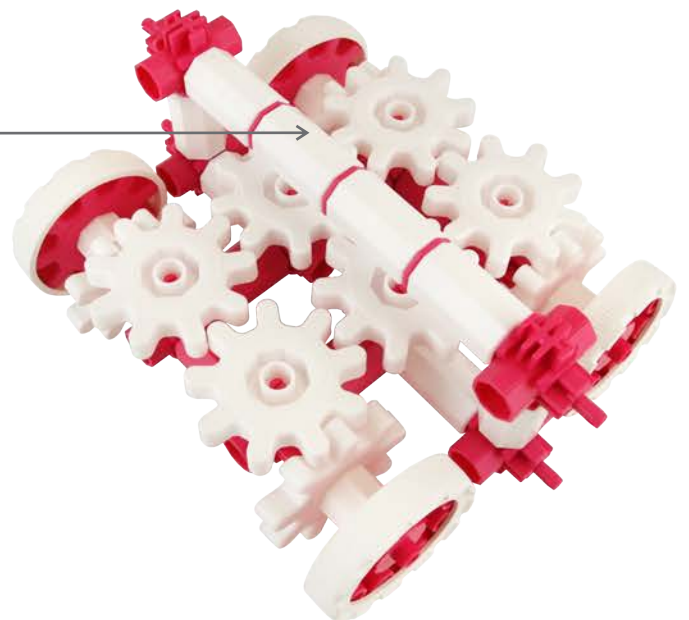

HOUSE



7x 4x 3x 4x 1x 12x 6x 8x 4x 8x 1x 1x 3x 3x

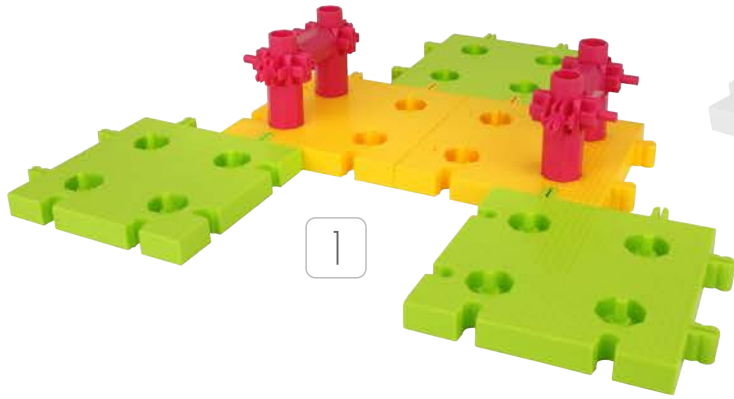

1



2

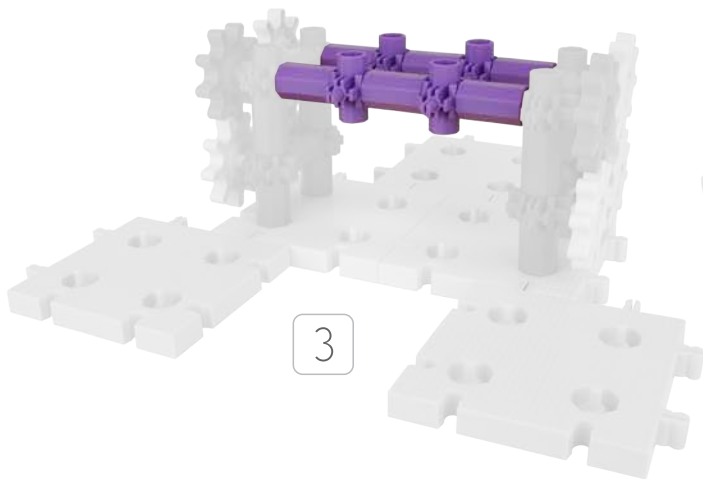

3

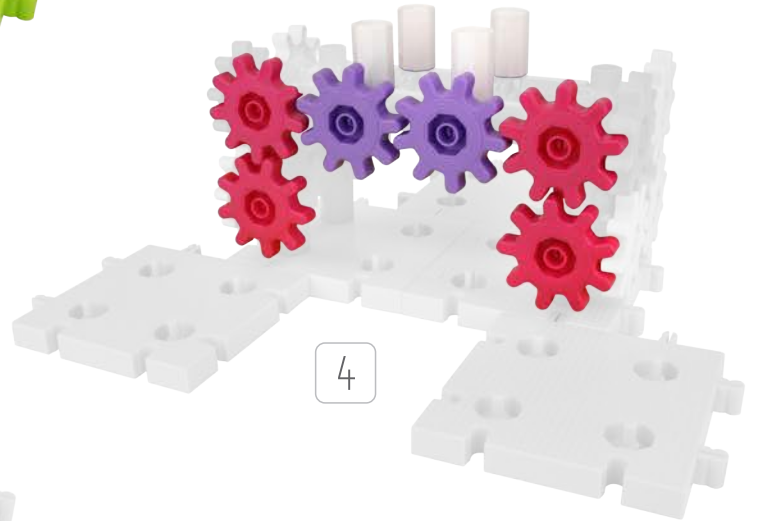

4

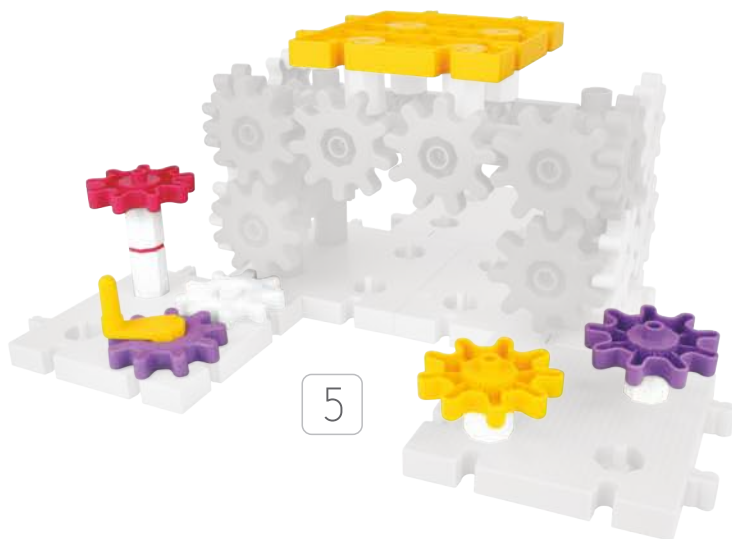

5

